

M12-A-5

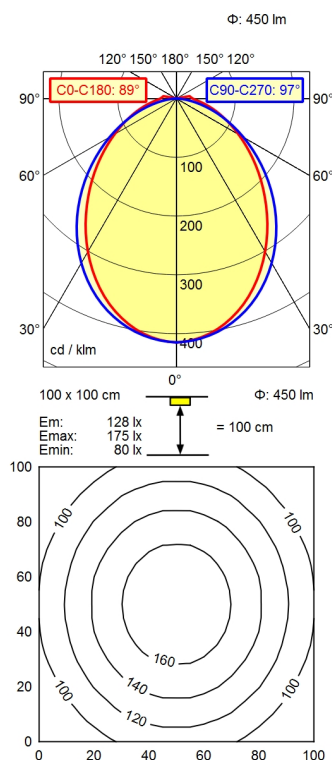

light source
work equipment
connected load
power consumption
luminous flux
luminous efficiency
light distribution
beam angle
colour temperature
glare control
system of protection
class of protection
technology
operation
housing
cover
weight (net)
mains lead
design
fastening
dimension

LED
without
22-26 V, DC
env. 9,0 W
approx. 450 lm
approx. 50 lm/W
direct
89° / 97°
yellow
screen
IP 54
III
switchable
external
aluminium/plastic; anodised, painted; aluminium
coloured anodised
Acrylic satine
env. 0,209 kg
built-in plug; M12-A-5
mounted version
bracket
A=475mm,Cmin=430mm,Cmax=460mm